

### Product introduction >>>----->>>>

JISIM JD5221 is a 40W constant current LED intelligent tunable white dimmable driver specifically designed for small aperture luminaires. It supports bluetooth dimming functions. The customized dimming curve provides a more comfortable viewing experience for the human eye. When not connected to an external signal, it can be used as a non-dimmable driver and supports a gradual start-up effect. It is suitable for small aperture downlights, LED spotlights and LED linear lights. Paired with various intelligent control systems, it is widely used in smart homes, smart hotels, intelligent commercial spaces, smart offices, smart buildings, and other facilities.



### Product Features >>>----->>>>

- Compact SELV independent dimmable driver
- Support bluetooth tunable white dimming
- Global certification, SELV equivalent
- Suitable for Class I/ II /III indoor light fixtures
- Smooth dimming, flicker-free, dimming range: 0.1-100%
- DIP switch for multi-current setting, Max. output power 40W
- Up to 50000 hours life time, 5-Year warranty (Long-lasting Capacitor)
- Small size and light weight, High power factor, High efficiency, Low THD
- The housing is made from V0 flame retardant PC materials from CHIMEI
- Standby power consumption <0.5 W, meets ErP energy efficiency certification



### Technical Specifications (All parameters not specially mentioned are measured at 230VAC input, full load and 25°C of ambient temperature) ----->>>>

Model	JD5221			Features	Output Type	Constant Current		
	Input	DC Voltage Range	120-300V		Communication mode	Bluetooth		
		AC Voltage Range	100-240V		Output Feature	Isolation		
		Rated Voltage	100Vac/230Vac		IP Rating	IP20		
		Input Frequency	50/60Hz		Insulation Rating	Class II (Suitable for class I II III light fixtures)		
		Input Current	≤0.6A/100Vac(at full load)		≤0.25A/230Vac(at full load)	Output	No Load Output Voltage	≤59V
		Input Power	Max.46W		Output Voltage Range		15-40Vdc	
		Power Factor	PF>0.95C/100Vac(at full load) PF>0.9C/230Vac(at full load)		Output Current Range		750-1050mA	
		THD	THD<10%/230Vac(at full load)		Output Power Range		10.5-40W	
		Efficiency	≥86%(at full load)		Dimming Range		0.1~100%	
Inrush Current		Cold start 15A(Test twidth=102us under 50% Ipeak@230Vac)		Ripple Current	<5%			
Anti-Surge	L-N:1KV		Current Accuracy	±5%				
Leakage Current	<0.5mA/230Vac		PWM Frequency	4000Hz				
Protection	Overload Protection	Hiccup Mode (Auto-Recovery after Elimination)		Environment	Working Temperature		ta: -20°C~45°C	
	Open Circuit Protection	≤59Vdc			Working Humidity		20~90%RH(No Condensation)	
	Short Circuit Protection	Hiccup Mode (Auto-Recovery after Elimination)			Storage Temperature/Humidity	-40~85°C/5~95%RH		
Safety & EMC	Withstand Voltage	I/P-O/P: 3750Vac, 5mA, 60s			Case Temperature	tc: 90°C		
	Insulation Resistance	I/P-O/P: 100MΩ/500VDC/25°C/70%RH			Life Time	>50000h@tc=90°C		
	Safety Standards	CCC	China	GB19510.1, GB19510.14				
		CE	European Union	EN61347-1, EN61347-2-13, EN62493				
		KC	Korea	KC61347-1, KC61347-2-13				
		TUV	Germany	EN61347-1, EN61347-2-13, EN62493				
		ENEC	Europe	EN61347-1, EN61347-2-13, EN IEC62384				
		CB	CB Member States	IEC61347-1, IEC61347-2-13				
		RCM	Australia	AS/NZS61347.1, AS61347.2.13				
		BIS	India	IS15885(PART2/SEC13)				
		EAC	Russia	IEC61347-1, IEC61347-2-13				
	UKCA	United Kingdom	BS EN61347-1, BS EN IEC61347-2-13, BS EN62493					
	EMC Emission	CCC	China	GB/T17743, GB17625.1				
		CE	European Union	EN IEC55015, EN IEC61000-3-2, EN61000-3-3				
		KC	Korea	KSC9815, KSC9547				
RCM		Australia	EN IEC55015, EN IEC61000-3-2, EN61000-3-3					
UKCA		United Kingdom	BS EN IEC55015, BS EN IEC6100-3-2, BS EN61000-3-3					
EAC		Russia	IEC62493.IEC61547, EN55015.IEC61000-3-2, IEC61000-3-3					
BIS	India	IS15885(PART2/SEC13)						
EMC Immunity	EN61000-4-2,3,4,5,6,8,11,EN61547							
ErP	Power Consumption	Standby Power Consumption	<0.5W (PWM Off)					
	Flicker/ Stroboscopic Effect	IEEE1789	Meet IEEE Std1789-2015					
		CIESVM	Pst≤1, SVM≤0.4					
DF	Phase Factor	DF≥0.9						
Test Equipment	AC Source	PS-61005	Withstand Voltage Tester	TH9302D	Other			
	DC Electronic Load	IT8512A+	Thermostatic Humidity Chamber	HT-H-802				
	Spectrum Analyzer	KH3932	Intelligent Electrical Parameter Meter	PF9800	LED Load			
	Surge Generator	SUG61005TB(7.5KV)-2216	Oscilloscope	TBS1102B				
	Stroboscope	LANSHU-201B	Digital Wattmeter	PM2818C				

## Bluetooth Tunable White Dimmable LED Driver

### LED Current Settings

Number	Output				Switch Position		
	Current (mA)	Voltage (VDC)	NO Load Outout Voltage (VDC)	Power (W)	1	2	3
1	700	15-40	59	28	/	/	/
2	750	15-40		30	ON	/	/
3	800	15-40		32	/	ON	/
4	850	15-40		34	ON	ON	/
5	900	15-40		36	/	/	ON
6	950	15-40		38	ON	/	ON
7	1000	15-40		40	/	ON	ON
8	1050	15-38		40	ON	ON	ON

◀ \* Factory default.

1. Please disconnect the AC input before adjusting the output current via the DIP switch, If not, it may damage the lighting fixture.

2. No Overload, The output power should be less than or equal to 40W.

### 2D Diagram

Length (L)	Width (D)	Heigh(H)	Weight(W)
165mm	42mm	30mm	185.7±10g

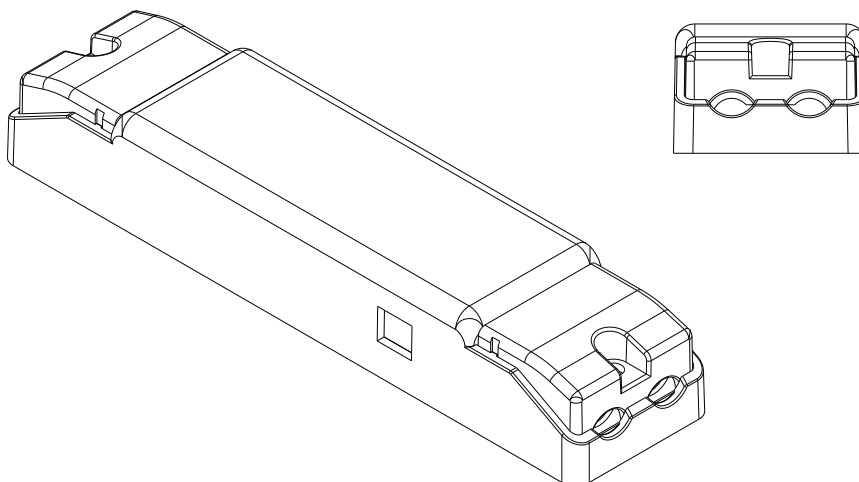
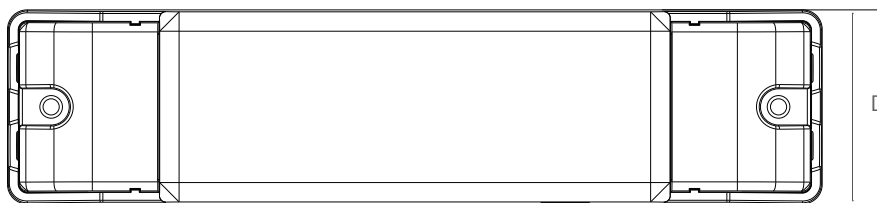

## Bluetooth Tunable White Dimmable LED Driver

### Wiring Diagram



### Installation Instructions

Interface	Marking	Description	Wire cross Section	Wire Stripping Length
Input	L	Input terminal of AC live wire	0.75...1.5mm <sup>2</sup> (16-18AWG)	5...6mm
	N	Input terminal of AC neutral wire	0.75...1.5mm <sup>2</sup> (16-18AWG)	5...6mm
Output	LED-W	Negative electrode output of warm light	0.5...1.0mm <sup>2</sup> (16-20AWG)	5...6mm
	LED-C	Negative electrode output of cold light	0.5...1.0mm <sup>2</sup> (16-20AWG)	5...6mm
	LED+	Positive electrode output of the driver	0.5...1.0mm <sup>2</sup> (16-20AWG)	5...6mm

#### ◦ Connection instructions ◦

1. Rated torque: M2.6, 0.35-0.40N.m
2. All connections must be as short as possible to ensure good EMI performance.
3. No secondary switches are allowed.
4. The driver output does not support hot swap
5. Incorrect wiring can damage the LED.
6. The power cable should be kept at a certain distance from the driver and other connecting cables (5-10cm recommended)

### App operation Instructions

#### 1. Account Registration

Download and install the Tuya Smart App on IOS/Android. Once installed, you can proceed with login/registration.

#### 2. Adding Devices

After new users navigate to "My" > "Family Management" > "Create Family" to set up family location and manage room names, they can click on the "My Home" interface to "Add Device". When the device is powered on, the light will enter a breathing state. In the add device list, select "Auto-Discover" to automatically search for devices. The "2Ch Driver TW CC" can be automatically discovered. Follow the prompts to complete device addition (ensure the device is powered on or reset and in breathing mode, and that a Bluetooth gateway has been added).

#### 3. Function Settings

After the device is successfully added, click on it to enter the specific lighting control interface, where you can freely control the device to turn on/off, adjust brightness, adjust color temperature, create groups, set schedules, and access more functions.

#### 4. Scenes and Automation

Based on individual needs, users can customize scenes and automations, with features such as a lighting scenario library, lighting music library, and biorhythmic lighting.

#### 5. Resetting Devices

To reset a device, quickly toggle the power on and off seven times. When the light enters breathing mode, it indicates that the device has been successfully reset and is ready for network configuration.

#### 6. Voice Control

The device supports control via Amazon Alexa, Google Assistant, SmartThings, Yandex Alice, Tmall Genie, Baidu Duer, Xiaomi XiaoAI, XiaoZhi Guanjia, Tencent WeChat Mini Programs, Tencent Dingdang, JD DingDong, and other voice assistants.

Product Characteristic Curves

Life Time VS Tcase

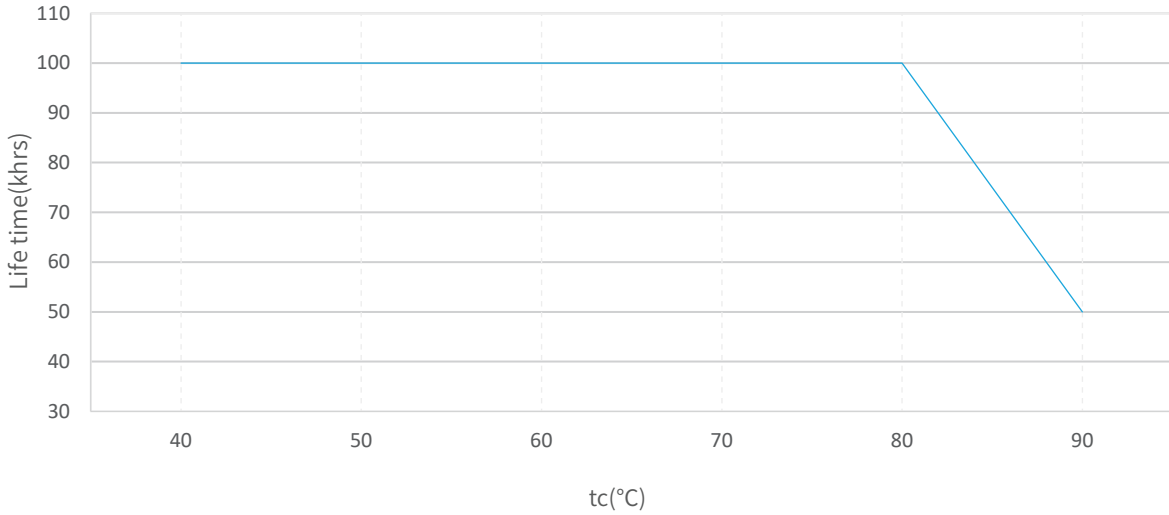

The life-time of the LED driver is shown in the figure above calculated (based on the 90% survival rate). The relation of tc to ta temperature depends also on the luminaire design.

Operating Window

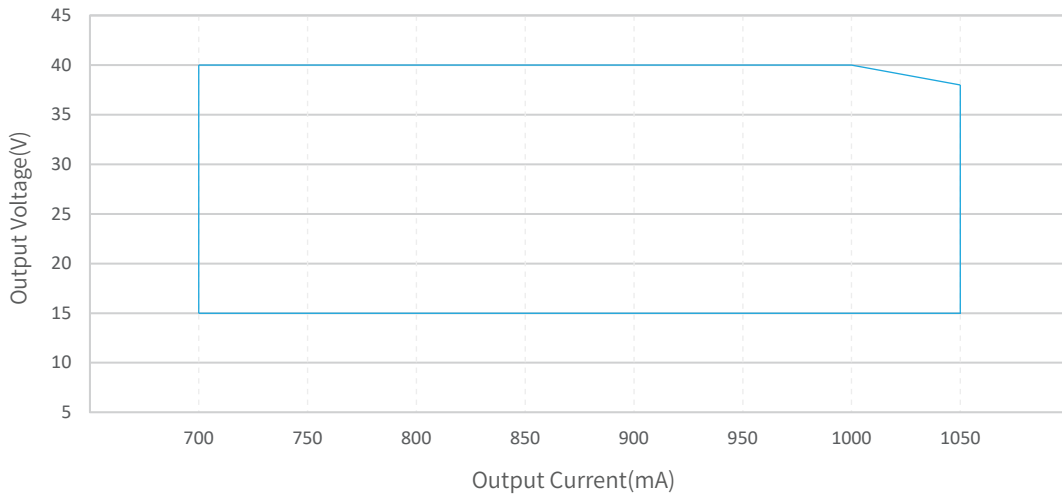

Power Factor VS @Load 230Vac

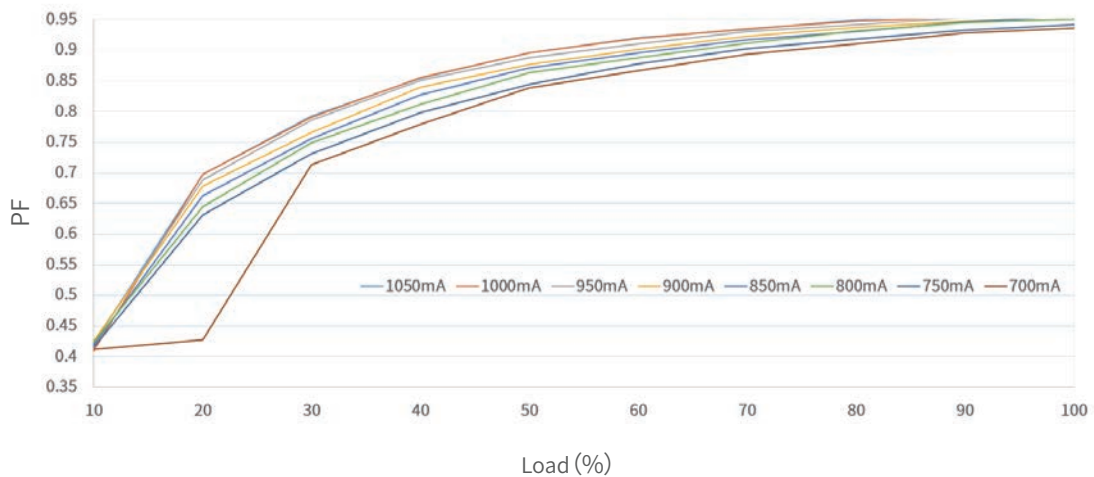

## Bluetooth Tunable White Dimmable LED Driver

THD VS @Load 230Vac

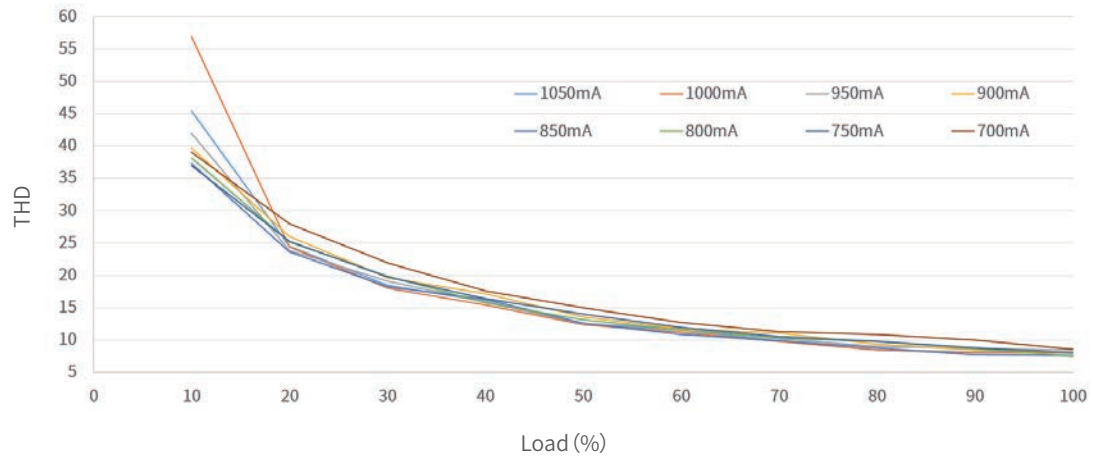

Efficiency VS Load@230Vac

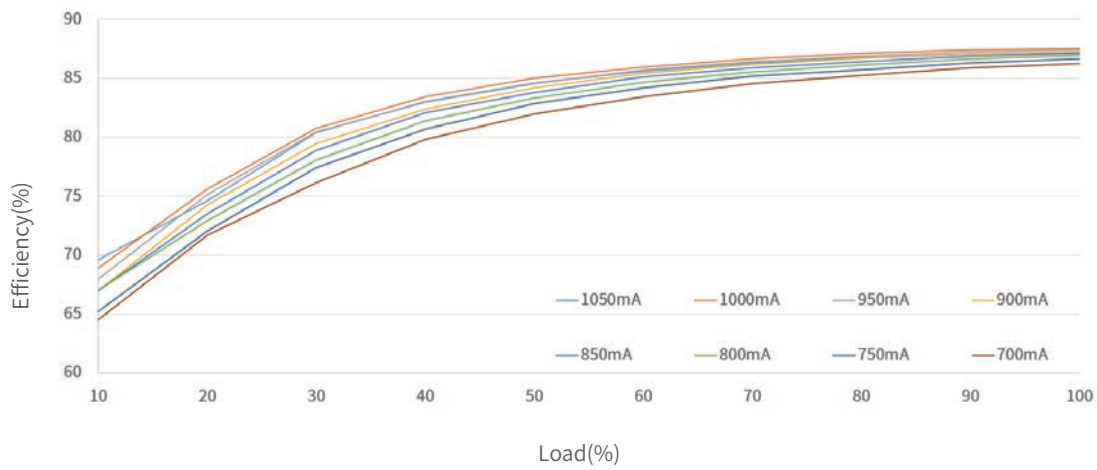

### Packaging Image



Inner Packaging Box



Large Carton Packaging



Small Carton Packaging

## Bluetooth Tunable White Dimmable LED Driver

## Packaging Size

Packaging Details	Carton Size	Packing Units	Weight
Inner Packaging Box	168x47x34mm	1pcs	202±10g
Small Carton Packaging	350 x 197 x 167mm	30pcs	6.36kg
Large Carton Packaging	420 x 360 x 365mm	120pcs	26.3kg

## Packaging instructions:

Each large carton packaging contains 4 small carton packagings, Each small carton packaging contains 30 inner packaging boxes.

## Cautions

- ▶ This product is used as a component in conjunction with a lighting fixture. Due to the influence of EMC from the lighting fixture and wiring, customers should perform EMC testing to confirm the entire product set.
- ▶ No operation with power on. Installation and debugging should be performed by qualified professionals. Please read the product manual carefully before installation.
- ▶ This product can only be used outside the light body, Cannot be used inside of the light, and it must be used with in the specified working environment.
- ▶ This product is not waterproof and should be avoided from direct sunlight and rain. If it is installed outdoors, please use a waterproof case.
- ▶ Good heat dissipation conditions are beneficial to the product's lifetime. Please install the product in a suitable environment, and strictly prohibit using double-sided tape to attach the casing or circuit board.
- ▶ Please check the parameters of the LED driver to ensure they meet the application requirements of the lighting fixture.
- ▶ Please install according to the standard wire gauge specified in the manual to avoid malfunctions caused by inappropriate wiring.
- ▶ Before powering on, please ensure that the wiring is correct to prevent damage to the driver or lighting fixture caused by incorrect wiring.
- ▶ If a malfunction occurs, please do not attempt to repair it yourself, if you have any questions, please contact the manufacturer.
- ▶ The manual is for reference only. Please refer to the actual product. Any changes to this product will not be notified separately.
- ▶ For more information, please send an email to fei.l@jisim-tech.com.

## Warranty Terms

- ▶ The product is warranted for 5 years. (The life and MTBF of the product are for reference only, and do not represent a warranty statement.)
- ▶ During the warranty period, if any quality issues arise, JISIM will provide free repair or replacement services.

## Non-Warranty Terms

The following situations are not covered by the free warranty or replacement service:

- ▶ The warranty period has expired.
- ▶ Damage caused by human factors such as overvoltage, overload, or improper operation.
- ▶ Deformation or damage to the exterior appearance.
- ▶ Damage caused by natural disasters or other irresistible human factors.
- ▶ The warranty label has been torn off or removed.
- ▶ No contract or invoice proof is provided.



## Notice:

1. Repair or replacement provided is the only remedy for customers. JISIM is not liable for any incidental or consequential damage unless it is within the law.
2. JISIM has the right to amend or adjust the terms of this warranty, and release in written form shall prevail.