

Product introduction >>>----->>>>

JISIM JD1126 is a constant-current LED intelligent dimming driver, a compact product specially designed for indoor small-aperture embedded lamps. It supports triac (forward and reverse edge phase-cut) dimming function, and has a built-in slow-bright start function. The customized dimming curve makes the human eye more comfortable. When no external signal is connected, it can be used as a conventional driver. It is suitable for LED downlights, LED linear lights, and is widely used in high-end places such as smart homes, smart hotels, intelligent commercial lighting, smart offices, and intelligent buildings.



Product Features >>>----->>>>

- Input voltage: 220-240Vac, global certification.
- V0 fire rating, Taiwan Chimei PC shell.
- Compact SELV independent dimming driver.
- Applicable to Class I/II/III indoor lighting fixtures.
- Smooth dimming, flicker-free, dimming range: 1-100%
- Compatible with most mainstream brand phase-cut dimmers on the market.
- DIP switch for multi-level current setting, with maximum output power of 30W.
- Up to 50,000 hours of service life with 5-year warranty (long-life capacitors).
- Small size, light weight, high power factor, high efficiency, and low harmonic.
- Supports forward and reverse edge phase-cut dimming functions.
- Standby power consumption <0.5W, compliant with ErP energy efficiency certification.

Technical Specifications (All parameters not specially mentioned are measured at 230VAC input, full load and 25°C of ambient temperature) ----->>>>

Model	JD1126			Output Type	Constant Current	
Input	DC Voltage Range	220-240V		Dimming Interface	Phase-cut dimming	
	AC Voltage Range	220-240V		Output Feature	Isolation	
	Rated Voltage	220Vac/230Vac/240Vac		IP Rating	IP20	
	Input Frequency	50/60Hz		Insulation Rating	Class II (Suitable for class I II III light fixtures)	
	Input Current	≤0.25A/230Vac(at full load)		No Load Output Voltage	≤46Vdc	
	Input Power	Max.48W		Output Voltage Range	26-42Vdc	
	Power Factor	PF>0.9C/230Vac(at full load)		Output Current Range	550-900mA	
	THD	THD<10%/230Vac(at full load)		Output Power Range	14.3-30W	
	Efficiency	≥85%(at full load)		Dimming Range	1~100% (Different dimmers have errors.)	
	Inrush Current	Cold start 14.8A(Test twidth=16.8us under 50% Ipeak@230Vac)		Ripple Current	<5%	
Anti-Surge	L-N:4KV		Current Accuracy	±5%		
Leakage Current	<0.5mA/230Vac					
Protection	Overload Protection	Hiccup Mode (Auto-Recovery after Elimination)		Working Temperature	ta:-20°C~45°C	
	Open Circuit Protection	≤46Vdc		Working Humidity	20~90%RH(No Condensation)	
	Stort Circuit Protection	Hiccup Mode (Auto-Recovery after Elimination)		Storage Temperature/Humidity	-40~85°C/5~95%RH	
				Case Temperature	tc:90°C	
Safety & EMC	Withstand Voltage	I/P-O/P: 3750Vac, 5mA, 60s			Life Time	>50000h@tc=90°C
	Insulation Resistance	I/P-O/P: 100MΩ/500VDC/25°C/70%RH				
	Safety Standards	CCC	China	GB19510.1, GB19510.14		
		CE	European Union	EN61347-1, EN61347-2-13, EN62493		
		KC	Korea	KC61347-1, KC61347-2-13		
		TUV	Germany	EN61347-1, EN61347-2-13, EN62493		
		ENEC	Europe	EN61347-1, EN61347-2-13, EN IEC62384		
		CB	CB Member States	IEC61347-1, IEC61347-2-13		
		RCM	Australia	AS/NZS61347.1, AS61347.2.13		
		BIS	India	IS15885(PART2/SEC13)		
		EAC	Russia	IEC61347-1, IEC61347-2-13		
	UKCA	United Kingdom	BS EN61347-1, BS EN IEC61347-2-13, BS EN62493			
	EMC Emission	CCC	China	GB/T17743, GB17625.1		
		CE	European Union	EN IEC55015, EN IEC61000-3-2, EN61000-3-3		
		KC	Korea	KSC9815, KSC9547		
RCM		Australia	EN IEC55015, EN IEC61000-3-2, EN61000-3-3			
UKCA		United Kingdom	BS EN IEC55015, BS EN IEC6100-3-2, BS EN61000-3-3			
EAC		Russia	IEC62493.IEC61547, EN55015.IEC61000-3-2, IEC61000-3-3			
BIS	India	IS15885(PART2/SEC13)				
EMC Immunity	EN61000-4-2,3,4,5,6,8,11,EN61547					
ErP	Power Consumption	Stanby Power Consumption	<0.5W			
	Flicker/ Stroboscopic Effect	IEEE1789	Meet IEEE Std1789-2015			
		CIESVM	Pst≤1, SVM≤0.4			
DF	Phase Factor	DF≥0.9				
Test Equipment	AC Source	PS-61005	Withstand Voltage Tester	TH9302D	Other	
	DC Electronic Load	IT8512A+	Thermostatic Humidity Chamber	HT-H-802		
	Spectrum Analyzer	KH3932	Ntelligent Electrical Parameter Meter	PF9800	LED Load	
	Surge Generator	SUG61005TB(7.5KV)-2216	Oscilloscope	TBS1102B		
	Stroboscope	LANSHU-201B	Digital Wattmeter	PM2818C		

Phase-cut Dimmable LED Driver

LED Current Settings

Number	Output				Switch Position		
	Current (mA)	Voltage (VDC)	NO Load Outout Voltage (VDC)	Power (W)	1	2	3
1	550	26-42	59	23.1	/	/	/
2	600	26-42		25.2	ON	/	/
3	650	26-42		27.3	/	ON	/
4	700	26-42		29.4	ON	ON	/
5	750	26-40		30	/	/	ON
6	800	26-37		29.6	ON	/	ON
7	850	26-35		29.8	/	ON	ON
8	900	26-33		29.7	ON	ON	ON

◀ * Factory default.

1. Please disconnect the AC input before adjusting the output current via the DIP switch, if not, it may damage the lighting fixture.
2. No Overload, The output power should be less than or equal to 30W.

2D Diagram

Length (L)	Width (D)	Heigh(H)	Weight(W)
165mm	42mm	30mm	185.7±10g

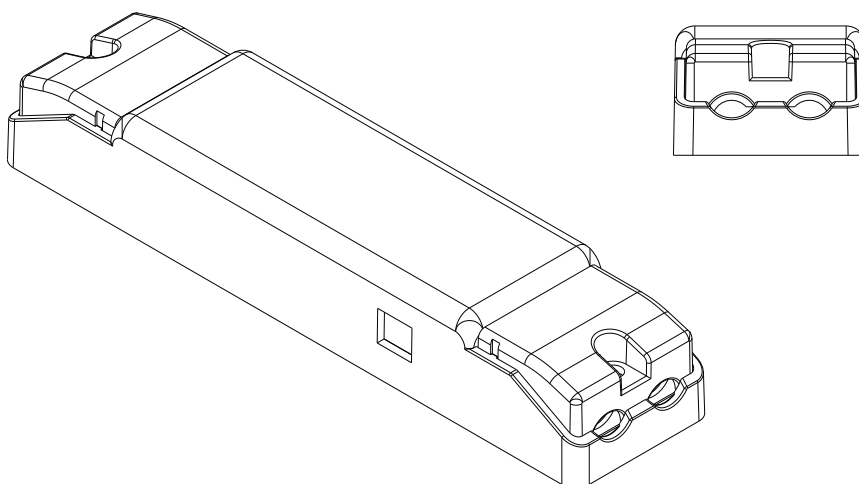
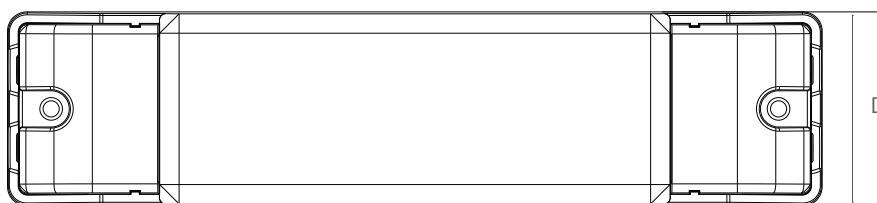

Phase-cut Dimmable LED Driver

Wiring Diagram

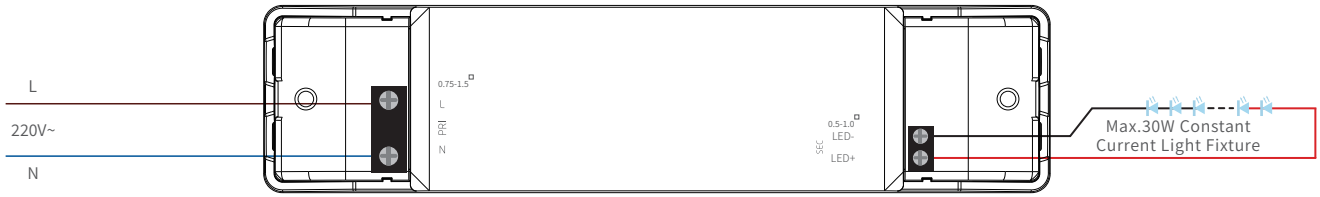

Installation Instructions

Interface	Marking	Description	wire cross Section	wire Stripping Length
Input	L	Input terminal of AC live wire	0.75...1.5mm ² (16-18AWG)	5...6mm
	N	Input terminal of AC neutral wire	0.75...1.5mm ² (16-18AWG)	5...6mm
Output	LED-	Negative electrode output of the driver	0.5...1.0mm ² (17-20AWG)	5...6mm
	LED+	Positive electrode output of the driver	0.5...1.0mm ² (17-20AWG)	5...6mm

Connection instructions

1. Rated torque: 0.35~0.40N.m
2. All connections must be as short as possible to ensure good EMI performance.
3. No secondary switches are allowed.
4. The driver output does not support hot swap
5. Incorrect wiring can damage the LED.
6. The power cable should be kept at a certain distance from the driver and other connecting cables (5-10cm recommended)

Installation Precautions

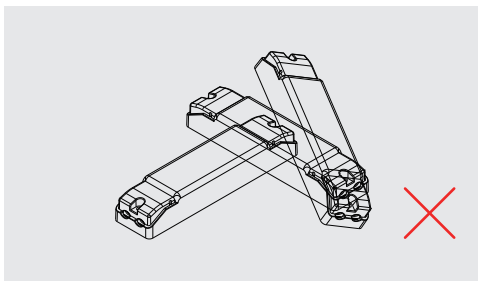

Do not stack the products. The distance between adjacent products should be more than 5 cm to avoid affecting the heat dissipation and service life of the products.

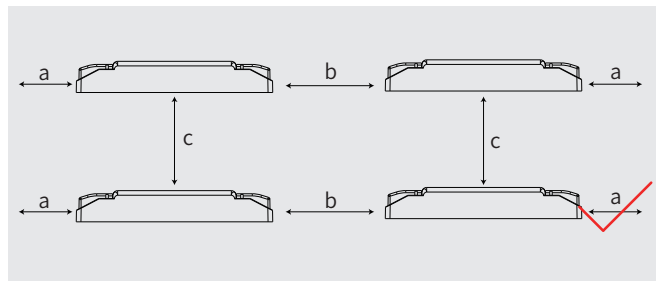

dimensions for safe installation should be: a>5cm; b>5cm; c>5cm

Product Characteristic Curves

Life Time VS Tcase

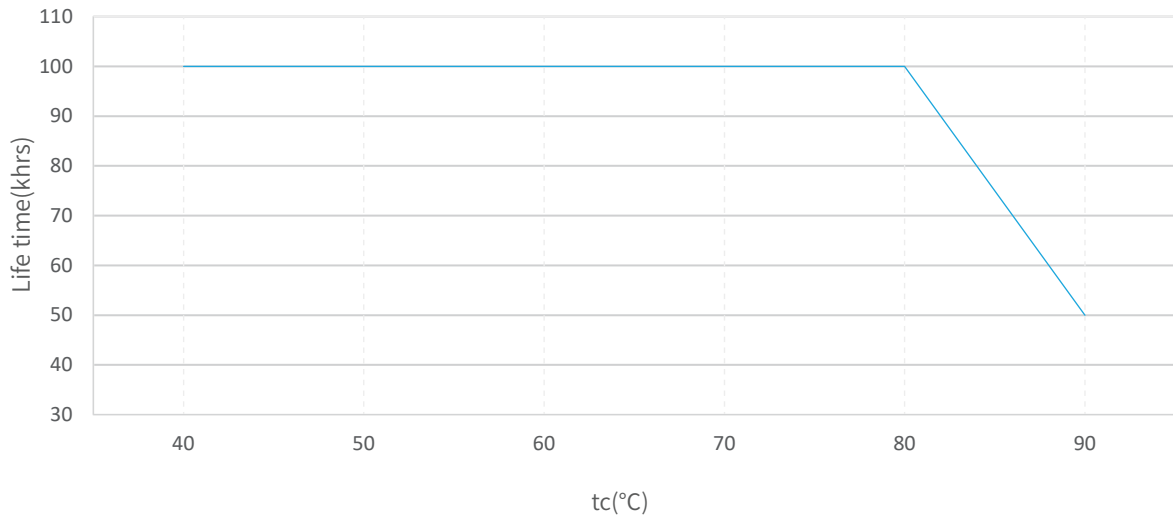

The life-time of the LED driver is shown in the figure above calculated (based on the 90% survival rate). The relation of tc to ta temperature depends also on the luminaire design.

Operating Window

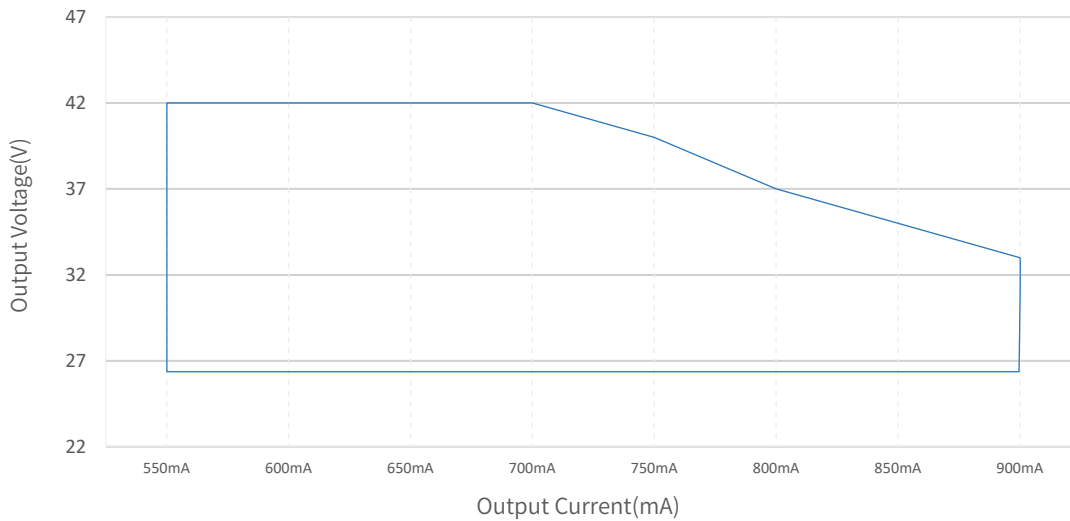

Power Factor VS @Load 230Vac

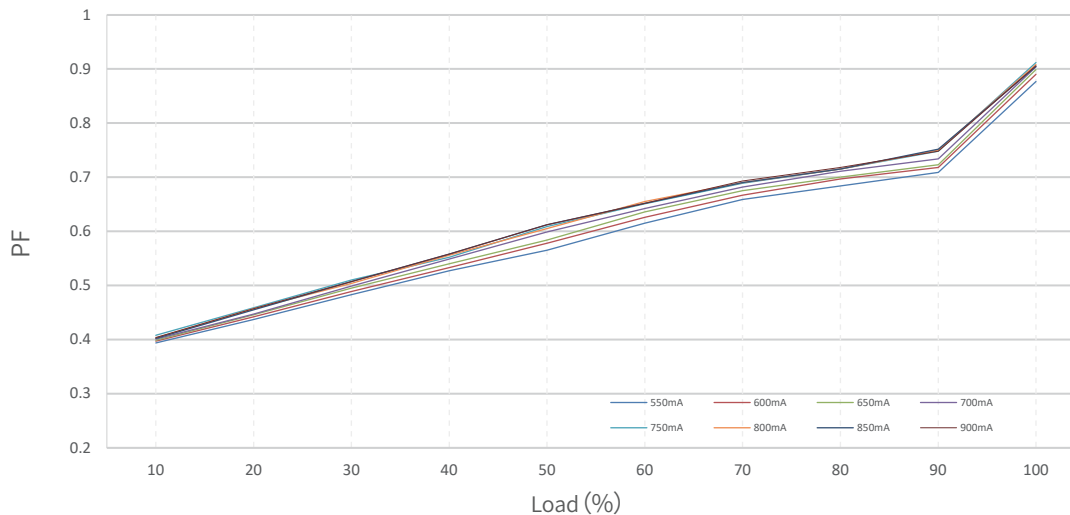

Phase-cut Dimmable LED Driver

Efficiency VS Load@230Vac

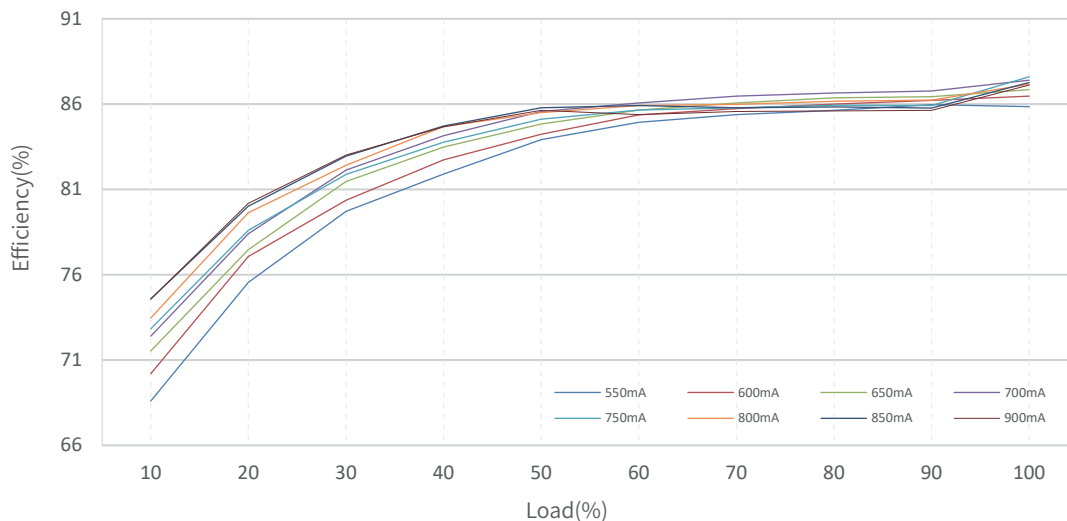

Packaging Image



Packaging Size

Packaging Details	Carton Size	Packing Units	Weight
Inner Packaging Box	168x47x34mm	1pcs	202±10g
Small Carton Packaging	350 x 197 x 167mm	30pcs	6.36kg
Large Carton Packaging	420 x 360 x 365mm	120pcs	26.3kg

Packaging instructions:

Each large carton packaging contains 4 small carton packagings, Each small carton packaging contains 30 inner packaging boxes.

Phase-cut Dimmable LED Driver

Cautions

- ▶ This product is used as a component in conjunction with a lighting fixture. Due to the influence of EMC from the lighting fixture and wiring, customers should perform EMC testing to confirm the entire product set.
- ▶ No operation with power on. Installation and debugging should be performed by qualified professionals. Please read the product manual carefully before installation.
- ▶ This product can only be used outside the light body, Cannot be used inside of the light, and it must be used within the specified working environment.
- ▶ This product is not waterproof and should be avoided from direct sunlight and rain. If it is installed outdoors, please use a waterproof case.
- ▶ Good heat dissipation conditions are beneficial to the product's lifetime. Please install the product in a suitable environment, and strictly prohibit using double-sided tape to attach the casing or circuit board.
- ▶ Please check the parameters of the LED driver to ensure they meet the application requirements of the lighting fixture.
- ▶ Please install according to the standard wire gauge specified in the manual to avoid malfunctions caused by inappropriate wiring.
- ▶ Before powering on, please ensure that the wiring is correct to prevent damage to the driver or lighting fixture caused by incorrect wiring.
- ▶ If a malfunction occurs, please do not attempt to repair it yourself, if you have any questions, please contact the manufacturer.
- ▶ The manual is for reference only. Please refer to the actual product. Any changes to this product will not be notified separately.
- ▶ For more information, please send an email to fei.l@jisim-tech.com.

Warranty Terms

- ▶ The product is warranted for 5 years. (The life and MTBF of the product are for reference only, and do not represent a warranty statement.)
- ▶ During the warranty period, if any quality issues arise, JISIM will provide free repair or replacement services.

Non-Warranty Terms

The following situations are not covered by the free warranty or replacement service:

- ▶ The warranty period has expired.
- ▶ Damage caused by human factors such as overvoltage, overload, or improper operation.
- ▶ Deformation or damage to the exterior appearance.
- ▶ Damage caused by natural disasters or other irresistible human factors.
- ▶ The warranty label has been torn off or removed.
- ▶ No contract or invoice proof is provided.



Notice:

1. Repair or replacement provided is the only remedy for customers. JISIM is not liable for any incidental or consequential damage unless it is within the law.
2. JISIM has the right to amend or adjust the terms of this warranty, and release in written form shall prevail.